

Ice Makers

Ice Cuber (22gr), 32kg/24h, 15kg bin, air-cooled

ITEM # _____

MODEL # _____

NAME # _____

SIS # _____

AIA # _____

730301 (ICB32I15SNP)

Ice Maker, Cube (22gr), 32 kg/24h, self-contained, 15kg ice collection bin included, air-cooled

Short Form Specification

Item No. _____

Air cooled ice cube maker, self-contained with 15kg bin. Ice cube cone shape. Compact dimension and height adjustable feet. AISI 304 stainless steel exterior, food grade and internal ice container in ABS, aluminium evaporator ensure safe contact with ice. Sturdy door opening system in AISI 204 stainless steel. Fully automatic in operation and easy cleanability thanks to the automatic cleaning system. The ice making method guarantees continuous and reliable production, crystalline and hygienically pure ice cubes. Bin with internal corner for easy cleaning and it is fully insulated. Supplied with flexible water supply, drain hoses and scoop. Hydrocarbon refrigerant gas R290 for the lowest environmental impact.

Main Features

- The ice making method guarantees a continuous and reliable production.
- Easy cleanability guaranteed by an automatic system: the cleaning switch activate the circulation and the rinse of water; at the end of the cycle just swithed again to start producing ice.
- The ice-making method (spray layering) guarantees crystalline, compact, hygienically pure ice cubes that are resistant to melting.
- Water consumption and productivity calculated using 15°C water temperature and 21°C ambient temperature.
- Compact dimensions of the ice cubers make them highly suitable for any location, particularly those where space is at a premium.
- Ice cube cone shape.
- Fully automatic in operation.
- Rounded internal corners of the bin assure ease of cleaning.
- Food grade ABS interior.
- Suitable for gravity drain only.
- Bin included.
- Compliant to CE requirements for safety.
- The innovative anti-scale spray system with flexible nozzles avoids limescale deposits through small vibrations.

Construction

- Reliability guaranteed by the quality of the construction materials used (front, top and sides in 304 AISI stainless steel) and the sophisticated product and process technology involved.
- The sprayers are easy to take away, permit a simple flowing and prevent limestone formation.
- AISI 304 stainless steel exterior.
- Aluminium evaporator ensures a safe contact with ice.
- Sturdy door opening system made in AISI 304 stainless steel.
- Internal ice containers in ABS.
- Hygienical plastic spray arms removable without the use of tools.
- Supplied with flexible water supply, drain hoses and scoop.
- Easy access to the main components for maintenance.
- ON-OFF rocker switch.
- Plug as standard (schuko type).

APPROVAL: _____



Electrolux
PROFESSIONAL

Ice Makers
Ice Cuber (22gr), 32kg/24h, 15kg
bin, air-cooled

Sustainability



- Hydrocarbon refrigerant gas R290 for the lowest environmental impact (GWP=3) - CFC and HCFC free.
- Reduced energy consumption by fully insulated storage bin.

Optional Accessories

- Drain pump kit PNC 880690



Ice Makers
Ice Cuber (22gr), 32kg/24h, 15kg bin, air-cooled

The company reserves the right to make modifications to the products without prior notice. All information correct at time of printing.

2024.09.21

Front



Side

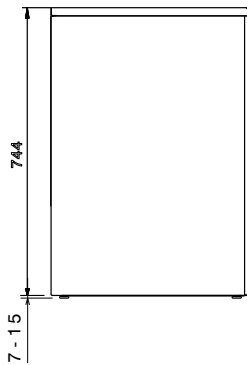

CW11 = Cold Water inlet 1 (cleaning)
 D = Drain
 EI = Electrical inlet (power)

Rear side

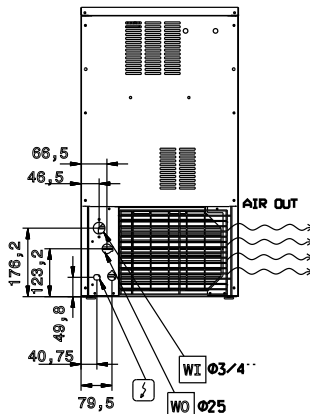

Top

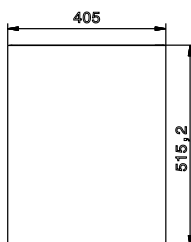

Electric

Supply voltage:

730301 (ICB32115SNP) 220-240 V/1N ph/50 Hz

Electrical power max.:

0.34 kW

Capacity:

Bin capacity:

15 kg

Key Information:

External dimensions, Width: 405 mm

External dimensions, Depth: 515 mm

External dimensions, Height: 757 mm

Net weight: 40 kg

Output: ISO 9001 kg/day

Kind of cube: Ice Cube 22 g

Sustainability

Refrigerant type: R290

Refrigerant weight: 80 g

Water consumption: 2.9 lt/hr